

2SC4208, 2SC4208A

Silicon NPN epitaxial planer type

For low-frequency output amplification and driver amplification

Complementary to 2SA1619 and 2SA1619A

Features

- Low collector to emitter saturation voltage $V_{CE(sat)}$.
- Output of 1W is obtained with a complementary pair with 2SA1619 and 2SA1619A.
- Allowing supply with the radial taping.

Absolute Maximum Ratings (Ta=25°C)

Parameter	Symbol	Ratings	Unit
Collector to base voltage	V_{CBO}	30	V
Collector to emitter voltage		60	
Emitter to base voltage	V_{EBO}	7	V
Peak collector current	I_{CP}	1	A
Collector current	I_C	500	mA
Collector power dissipation	P_C	1	W
Junction temperature	T_j	150	°C
Storage temperature	T_{stg}	-55 ~ +150	°C

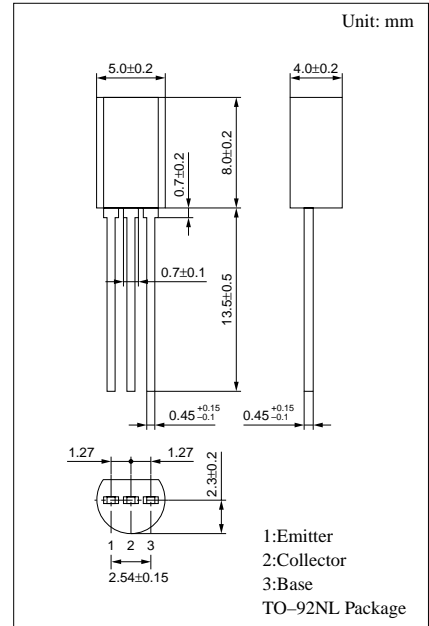

Electrical Characteristics (Ta=25°C)

Parameter	Symbol	Conditions	min	typ	max	Unit
Collector cutoff current	I_{CBO}	$V_{CB} = 20V, I_E = 0$			0.1	μA
Collector to base voltage	V_{CBO}	$I_C = 10\mu A, I_E = 0$	30			V
			60			
Collector to emitter voltage	V_{CEO}	$I_C = 10mA, I_B = 0$	25			V
			50			
Emitter to base voltage	V_{EBO}	$I_E = 10\mu A, I_C = 0$	7			V
Forward current transfer ratio	h_{FE1}^{*1}	$V_{CE} = 10V, I_C = 150mA^{*2}$	85		340	
	h_{FE2}	$V_{CE} = 10V, I_B = 500mA^{*2}$	40			
Collector to emitter saturation voltage	$V_{CE(sat)}$	$I_C = 300mA, I_B = 30mA$		0.35	0.6	V
Base to emitter saturation voltage	$V_{BE(sat)}$	$I_C = 300mA, I_B = 30mA$		1.1	1.5	V
Transition frequency	f_T	$V_{CB} = 10V, I_E = -50mA, f = 200MHz$		150		MHz
Collector output capacitance	C_{ob}	$V_{CB} = 10V, I_E = 0, f = 1MHz$		6	15	pF

*2 Pulse measurement

*1 h_{FE1} Rank classification

Rank	Q	R	S
h_{FE1}	85 ~ 170	120 ~ 240	170 ~ 340

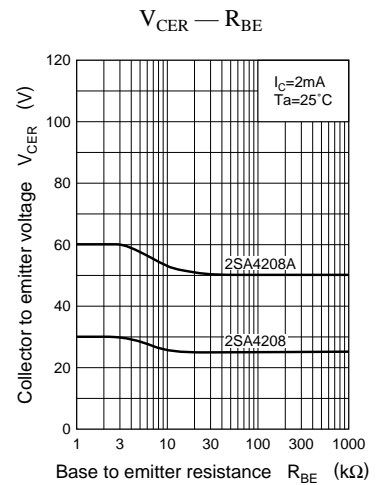
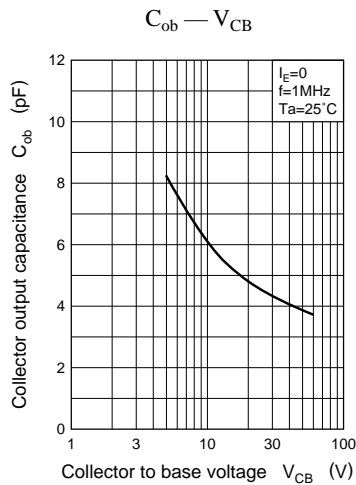
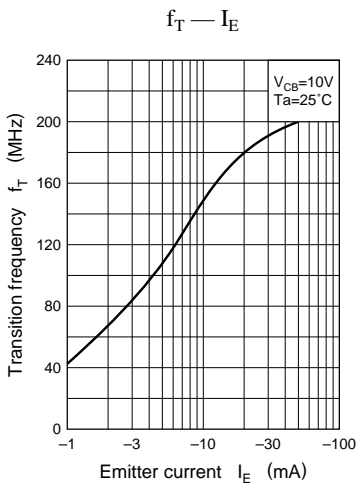
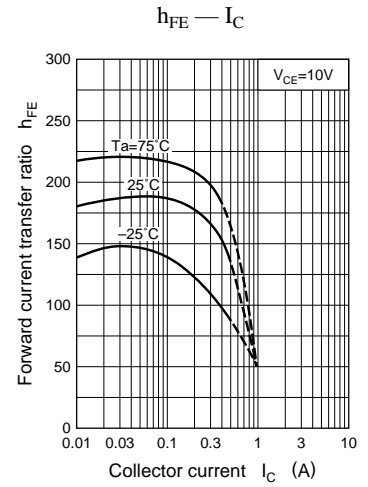
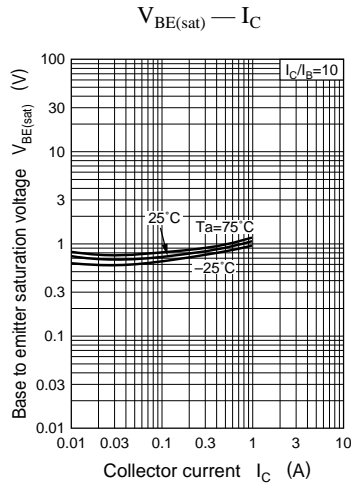
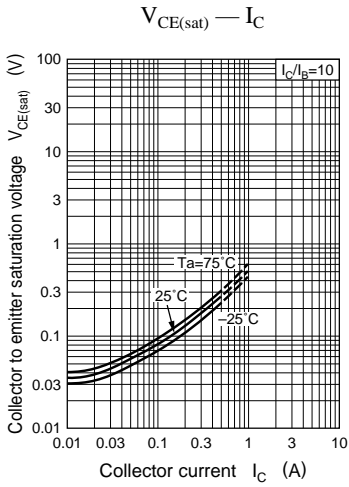
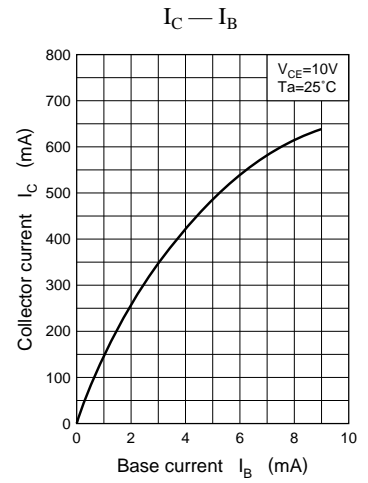
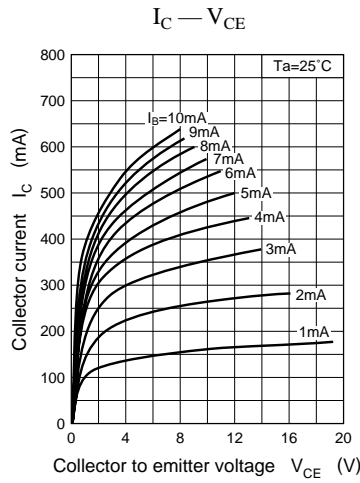
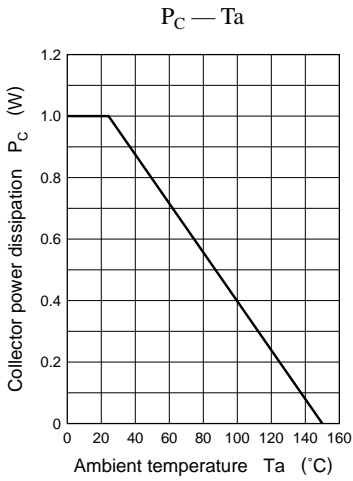

$I_{CEO} - T_a$

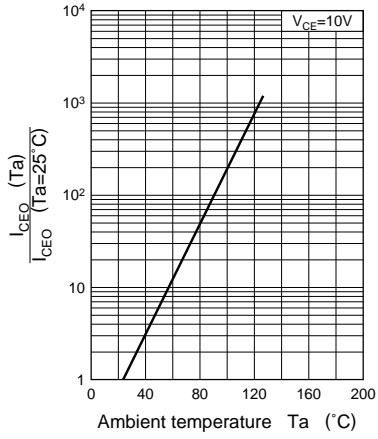

Area of safe operation (ASO)

