

Silicon NPN Epitaxial Type

2SC3303

FEATURES

- Low collector saturation voltage:
 $V_{CE(sat)}=0.4V(max)(I_C=3A)$.
- High speed switching time: $t_{stg}=1\mu s(typ)$.



Lead-free

APPLICATIONS

- High Current Switching Applications.
- DC-DC Converter Applications.

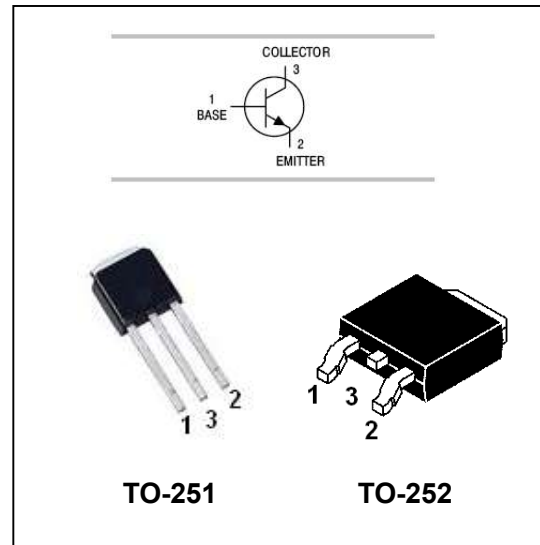

MAXIMUM RATING operating temperature range applies unless otherwise specified

Symbol	Parameter	Value	Units
V_{CBO}	Collector-Base Voltage	100	V
V_{CEO}	Collector-Emitter Voltage	80	V
V_{EBO}	Emitter-Base Voltage	7	V
I_C	Collector Current(DC)	5	A
I_{CP}	Collector Current(Pulse)	8	A
I_B	Base Current	1	A
P_C	Collector Power Dissipation	1	W
T_j, T_{stg}	Junction and Storage temperature range	-55 to +150	°C

Silicon NPN Epitaxial Type

2SC3303

ELECTRICAL CHARACTERISTICS @ $T_a=25^\circ\text{C}$ unless otherwise specified

Parameter	Symbol	Test conditions	MIN	TYP	MAX	UNIT
Collector-emitter breakdown voltage	V_{CEO}	$I_C=10\text{mA}, I_B=0$	80			V
Emitter-base breakdown voltage	V_{EBO}	$I_E=1\text{mA}, I_C=0$	7			V
Collector cut-off current	I_{CBO}	$V_{CB}=100\text{V}, I_E=0$			1.0	μA
Emitter cut-off current	I_{EBO}	$V_{EBO}=7\text{V}, I_C=0$			1.0	μA
DC current gain	h_{FE}	$V_{CE}=1\text{V}, I_C=1\text{A}$ $V_{CE}=1\text{V}, I_C=3\text{A}$	70 40		240	
Collector-emitter saturation voltage	$V_{CE(sat)}$	$I_C=3\text{A}, I_B=0.15\text{A}$		0.2	0.4	V
Base-emitter saturation voltage	$V_{BE(sat)}$	$I_C=3\text{A}, I_B=0.15\text{A}$		0.9	1.2	V
Transition frequency	f_T	$V_{CE}=4\text{V}, I_C=1\text{A}$		120		MHz
Collector output capacitance	C_{ob}	$V_{CB}=10\text{V}, I_E=0, f=1\text{MHz}$		80		pF

CLASSIFICATION OF $h_{FE(1)}$

Rank	O	Y
Range	70-140	120-240

Silicon NPN Epitaxial Type

2SC3303

TYPICAL CHARACTERISTICS @ $T_a=25^\circ\text{C}$ unless otherwise specified

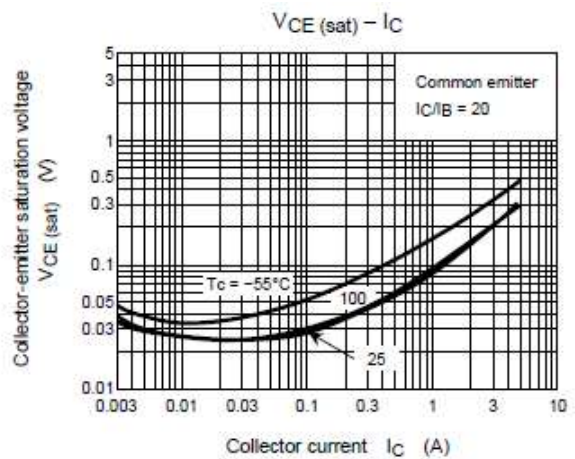
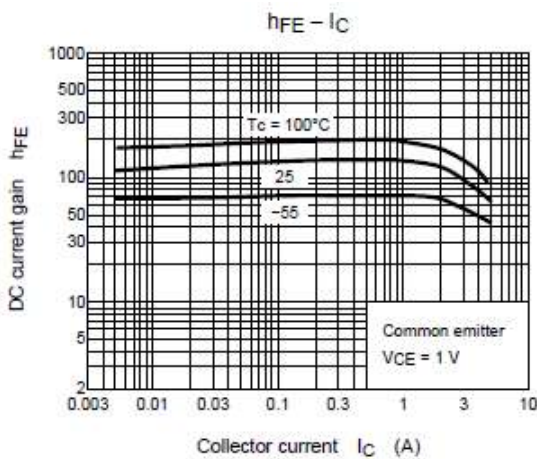
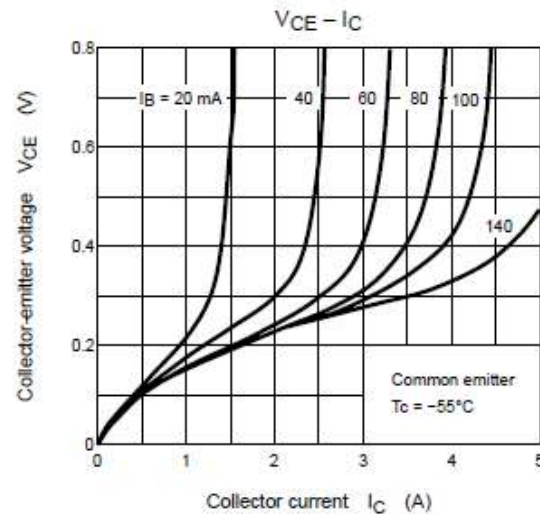
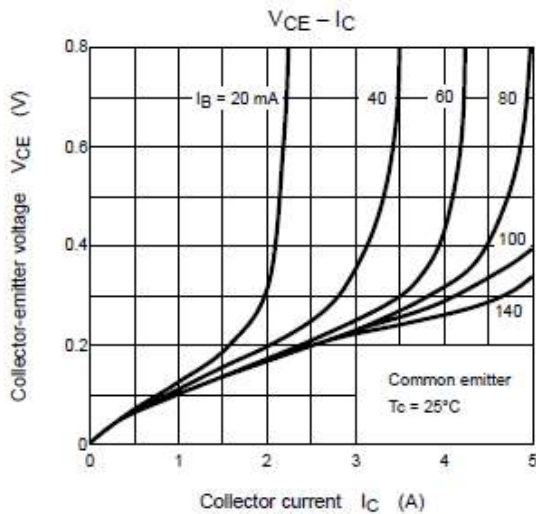
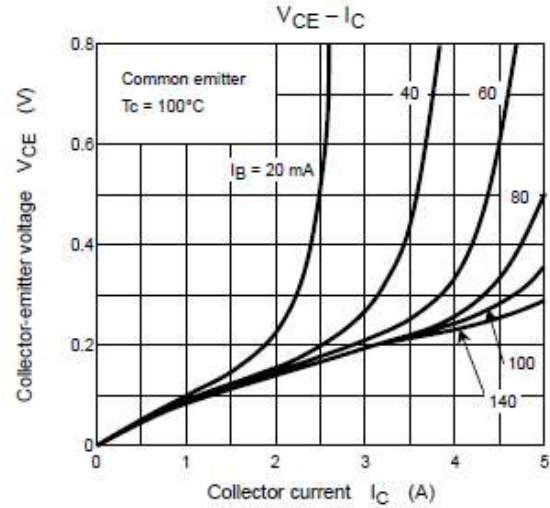
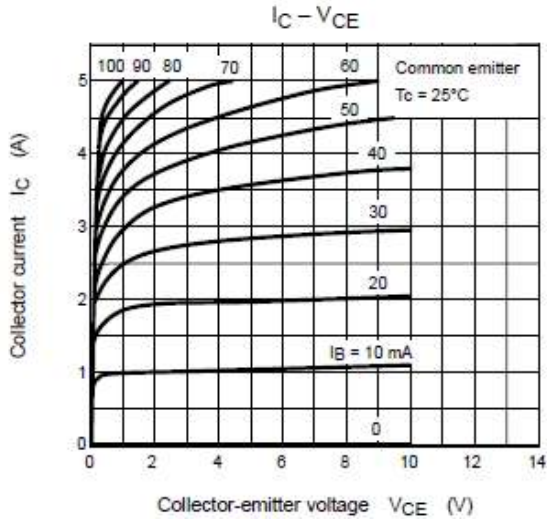

Silicon NPN Epitaxial Type

2SC3303

PACKAGE OUTLINE

Plastic surface mounted package

TO-251

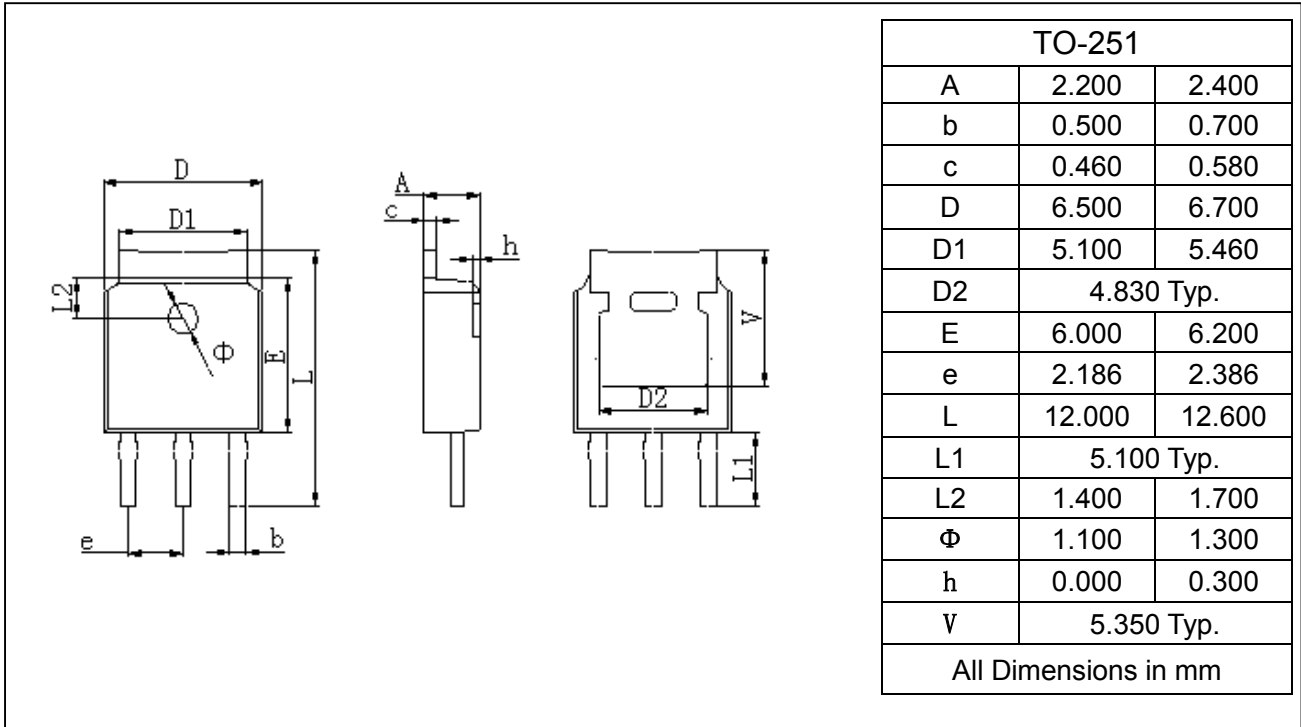

PACKAGE OUTLINE

Plastic surface mounted package

TO-252

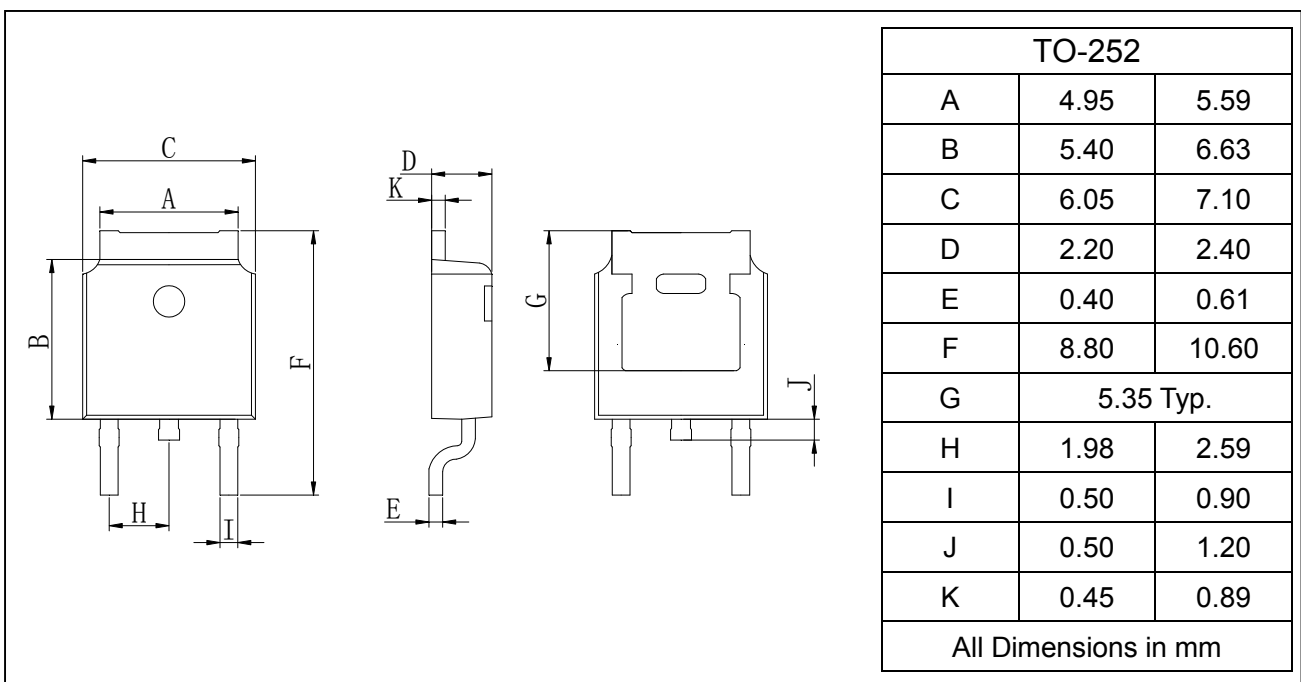

Silicon NPN Epitaxial Type

2SC3303

SOLDERING FOOTPRINT

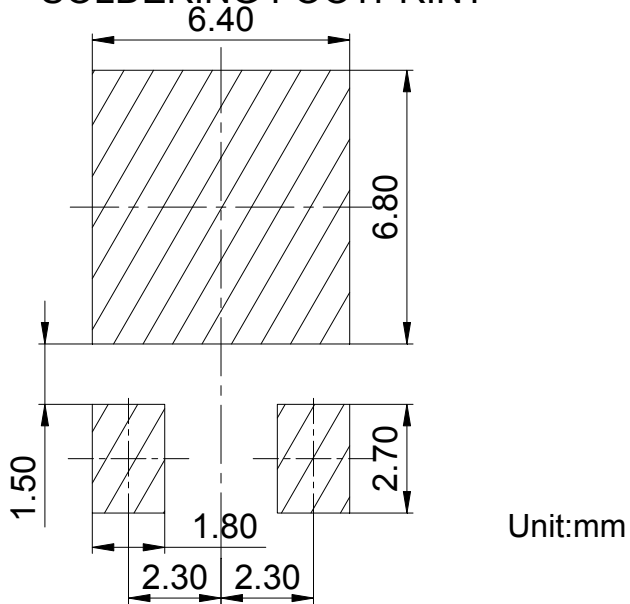

PACKAGE INFORMATION

Device	Package	Shipping
2SC3303	TO-251/252	80PCS/Tube
	TO-252	2500PCS/Tape&Reel