



Aries Low Cost, Quick Turn Small Outline Prototyping Adapters

FEATURES

- Mates SOT23, SOIC, MSOP, or TSSOP packages to standard breadboard and breakout boards for rapid and easy prototyping
- Panelized adapters available upon request

GENERAL SPECIFICATIONS

- BOARD MATERIAL: 0.062 [1.58] thick FR-4, UL 94V-0 with 1/2-oz. Cu traces
- PIN INSULATOR: Polyester, UL 94V-0
- PINS: Brass 360 1/2-hard per UNS C36000 ASTM-B16-00
- PIN PLATING: Au Flash
- OPERATING TEMPERATURE: -55°C to +125°C

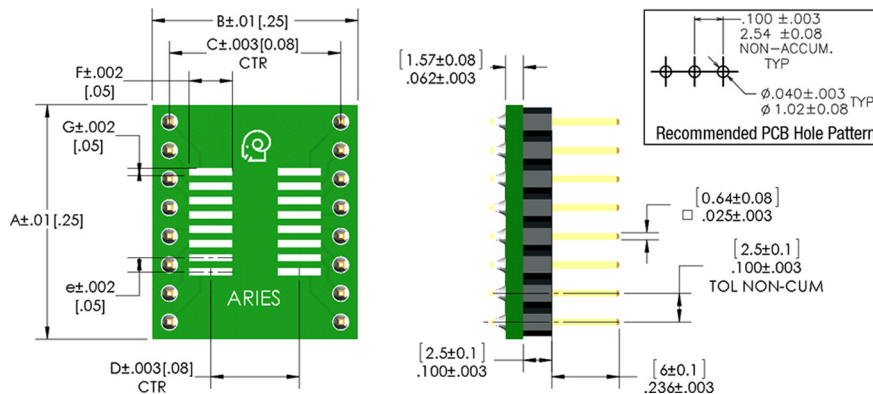
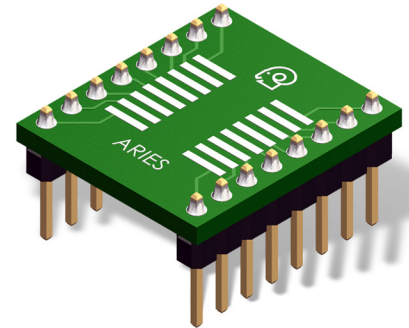

ORDERING INFORMATION

Indicate desired P/N

Pads	Package	Dim. "A"	Dim. "B"	Dim. "C"	Dim. "D"	Dim. "e"	Dim. "F"	Dim. "G"	P/N
6	SOT23	0.3 [7.62]	0.4 [10.16]	0.3 [7.62]	0.091 [2.30]	0.037 [0.95]	0.035 [0.90]	0.024 [0.60]	LCQT-SOT23
8	SOIC8	0.4 [10.16]	0.4 [10.16]	0.3 [7.62]	0.205 [5.20]	0.050 [1.27]	0.087 [2.20]	0.024 [0.60]	LCQT-SOIC8
10	MSOP10	0.5 [12.7]	0.4 [10.16]	0.3 [7.62]	0.161 [4.10]	0.020 [0.50]	0.039 [1.00]	0.012 [0.30]	LCQT-MSOP10
14	TSSOP14	0.7 [17.78]	0.7 [17.78]	0.3 [7.62]	0.230 [5.48]	0.026 [0.65]	0.039 [1.00]	0.012 [0.30]	LCQT-TSSOP14
14	SOIC14	0.7 [17.78]	0.7 [17.78]	0.6 [15.24]	0.205 [5.20]	0.050 [1.27]	0.087 [2.20]	0.024 [0.60]	LCQT-SOIC14
14	SOIC14W	0.7 [17.78]	0.7 [17.78]	0.6 [15.24]	0.362 [9.20]	0.050 [1.27]	0.087 [2.20]	0.024 [0.60]	LCQT-SOIC14W
16	TSSOP16	0.8 [20.32]	0.7 [17.78]	0.6 [15.24]	0.314 [7.98]	0.026 [0.65]	0.070 [1.78]	0.017 [0.42]	LCQT-TSSOP16
16	SOIC16	0.8 [20.32]	0.7 [17.78]	0.6 [15.24]	0.242 [6.15]	0.050 [1.27]	0.080 [2.03]	0.026 [0.66]	LCQT-SOIC16
16	SOIC16W	0.8 [20.32]	0.7 [17.78]	0.6 [15.24]	0.386 [9.80]	0.050 [1.27]	0.080 [2.03]	0.026 [0.66]	LCQT-SOIC16W
20	TSSOP20	1.0 [25.4]	0.7 [17.78]	0.6 [15.24]	0.222 [5.64]	0.026 [0.65]	0.012 [0.30]	0.039 [0.99]	LCQT-TSSOP20
20	SSOP20	1.0 [25.4]	0.7 [17.78]	0.6 [15.24]	0.285 [7.25]	0.026 [0.65]	0.059 [1.50]	0.016 [0.40]	LCQT-SSOP20
20	SOIC20W	1.0 [25.4]	0.7 [17.78]	0.6 [15.24]	0.396 [10.06]	0.050 [1.27]	0.080 [2.03]	0.026 [0.66]	LCQT-SOIC20W
28	TSSOP28	1.4 [35.56]	0.7 [17.78]	0.6 [15.24]	0.228 [5.80]	0.026 [0.65]	0.047 [1.20]	0.014 [0.35]	LCQT-TSSOP28
28	SOIC28	1.4 [35.56]	0.7 [17.78]	0.6 [15.24]	0.380 [9.65]	0.050 [1.27]	0.079 [2.00]	0.031 [0.80]	LCQT-SOIC28
32	SOIC32	1.6 [40.64]	0.7 [17.78]	0.6 [15.24]	0.362 [9.20]	0.050 [1.27]	0.087 [2.20]	0.024 [0.60]	LCQT-SOIC32
32	SOIC32W	1.6 [40.64]	0.7 [17.78]	0.6 [15.24]	0.425 [10.80]	0.050 [1.27]	0.087 [2.20]	0.024 [0.60]	LCQT-SOIC32W
32	TSOP I	1.6 [40.64]	0.7 [17.78]	0.6 [15.24]	0.598 [15.20]	0.020 [0.50]	0.063 [1.60]	0.012 [0.30]	LCQT-TSOP32-1
32	TSOP I	2.0 [50.8]	0.7 [17.78]	0.6 [15.24]	0.776 [19.70]	0.020 [0.50]	0.047 [1.20]	0.014 [0.36]	LCQT-TSOP32
40	TSOP I	2.0 [50.8]	0.7 [17.78]	0.6 [15.24]	0.598 [15.20]	0.020 [0.50]	0.063 [1.60]	0.012 [0.30]	LCQT-TSOP40
40	TSOP I	2.0 [50.8]	0.7 [17.78]	0.6 [15.24]	0.756 [19.20]	0.020 [0.50]	0.063 [1.60]	0.012 [0.30]	LCQT-TSOP40-1

• ALL DIMENSIONS: INCHES [MILLIMETERS] • ALL TOLERANCES: ±0.005 [0.13] UNLESS OTHERWISE SPECIFIED • CONSULT FACTORY FOR OTHER SIZES AND CONFIGURATIONS

CUSTOMIZATION: ARIES SPECIALIZES IN CUSTOM DESIGN AND PRODUCTION. SPECIAL MATERIALS, PLATINGS, SIZES, AND CONFIGURATIONS CAN BE FURNISHED, DEPENDING ON QUANTITY.

ARIES RESERVES THE RIGHT TO CHANGE PRODUCT GENERAL SPECIFICATIONS WITHOUT NOTICE

PRINTOUTS OF THIS DOCUMENT MAY BE OUT-OF-DATE AND SHOULD BE CONSIDERED UNCONTROLLED



ARIES
ELECTRONICS, INC.

2609 Bartram Road • Bristol, PA 19007-6810 USA
TEL 215-781-9956 • FAX 215-781-9845
WWW.ARIESELEC.COM • INFO@ARIESELEC.COM

19000
Rev. 1.1
1 of 1