

## N - CHANNEL ENHANCEMENT MODE POWER MOS TRANSISTOR

| TYPE       | V <sub>DSS</sub> | R <sub>DS(on)</sub> | I <sub>D</sub> |
|------------|------------------|---------------------|----------------|
| STP30N06   | 60 V             | < 0.05 Ω            | 30 A           |
| STP30N06FI | 60 V             | < 0.05 Ω            | 19 A           |

- TYPICAL R<sub>DS(on)</sub> = 0.045 Ω
- AVALANCHE RUGGED TECHNOLOGY
- 100% AVALANCHE TESTED
- REPETITIVE AVALANCHE DATA AT 100°C
- LOW GATE CHARGE
- HIGH CURRENT CAPABILITY
- 175°C OPERATING TEMPERATURE
- APPLICATION ORIENTED CHARACTERIZATION

### APPLICATIONS

- HIGH CURRENT, HIGH SPEED SWITCHING
- SOLENOID AND RELAY DRIVERS
- REGULATORS
- DC-DC & DC-AC CONVERTERS
- MOTOR CONTROL, AUDIO AMPLIFIERS
- AUTOMOTIVE ENVIRONMENT (INJECTION, ABS, AIR-BAG, LAMPDRIVERS, Etc.)



### ABSOLUTE MAXIMUM RATINGS

| Symbol              | Parameter   | Value      |            | Unit |
|---------------------|---|------------|------------|------|
|                     |   | STP30N06   | STP30N06FI |      |
| V <sub>DS</sub>     | Drain-source Voltage (V <sub>GS</sub> = 0)            | 60         |            | V    |
| V <sub>DGR</sub>    | Drain- gate Voltage (R <sub>GS</sub> = 20 kΩ)         | 60         |            | V    |
| V <sub>GS</sub>     | Gate-source Voltage                                   | ± 20       |            | V    |
| I <sub>D</sub>      | Drain Current (continuous) at T <sub>c</sub> = 25 °C  | 30         | 19         | A    |
| I <sub>D</sub>      | Drain Current (continuous) at T <sub>c</sub> = 100 °C | 21         | 13         | A    |
| I <sub>DM</sub> (•) | Drain Current (pulsed)                                | 120        | 120        | A    |
| P <sub>tot</sub>    | Total Dissipation at T <sub>c</sub> = 25 °C           | 105        | 40         | W    |
|                     | Derating Factor                                       | 0.7        | 0.27       | W/°C |
| V <sub>ISO</sub>    | Insulation Withstand Voltage (DC)                     | —          | 2000       | V    |
| T <sub>stg</sub>    | Storage Temperature                                   | -65 to 175 |            | °C   |
| T <sub>j</sub>      | Max. Operating Junction Temperature                   | 175        |            | °C   |

(•) Pulse width limited by safe operating area

## THERMAL DATA

|                       |  | TO-220 | ISOWATT220 |      |      |
|-----------------------|--|--------|------------|------|------|
| R <sub>thj-case</sub> | Thermal Resistance Junction-case               | Max    | 1.43       | 3.57 | °C/W |
| R <sub>thj-amb</sub>  | Thermal Resistance Junction-ambient            | Max    | 62.5       |      | °C/W |
| R <sub>thc-sink</sub> | Thermal Resistance Case-sink                   | Typ    | 0.5        |      | °C/W |
| T <sub>l</sub>        | Maximum Lead Temperature For Soldering Purpose |        | 300        |      | °C   |

## AVALANCHE CHARACTERISTICS

| Symbol          | Parameter  | Max Value | Unit |
|-----------------|--|-----------|------|
| I <sub>AR</sub> | Avalanche Current, Repetitive or Not-Repetitive (pulse width limited by T <sub>j</sub> max, δ < 1%)                          | 30        | A    |
| E <sub>AS</sub> | Single Pulse Avalanche Energy (starting T <sub>j</sub> = 25 °C, I <sub>D</sub> = I <sub>AR</sub> , V <sub>DD</sub> = 25 V)   | 160       | mJ   |
| E <sub>AR</sub> | Repetitive Avalanche Energy (pulse width limited by T <sub>j</sub> max, δ < 1%)  | 40        | mJ   |
| I <sub>AR</sub> | Avalanche Current, Repetitive or Not-Repetitive (T <sub>c</sub> = 100 °C, pulse width limited by T <sub>j</sub> max, δ < 1%) | 21        | A    |

ELECTRICAL CHARACTERISTICS (T<sub>case</sub> = 25 °C unless otherwise specified)

OFF

| Symbol               | Parameter   | Test Conditions  | Min. | Typ. | Max.    | Unit     |
|----------------------|---|--|------|------|---------|----------|
| V <sub>(BR)DSS</sub> | Drain-source Breakdown Voltage                        | I <sub>D</sub> = 250 μA V <sub>GS</sub> = 0  | 60   |      |         | V        |
| I <sub>DSS</sub>     | Zero Gate Voltage Drain Current (V <sub>GS</sub> = 0) | V <sub>DS</sub> = Max Rating<br>V <sub>DS</sub> = Max Rating x 0.8 T <sub>c</sub> = 125 °C |      |      | 1<br>10 | μA<br>μA |
| I <sub>GSS</sub>     | Gate-body Leakage Current (V <sub>DS</sub> = 0)       | V <sub>GS</sub> = ± 20 V   |      |      | ± 100   | nA       |

ON (\*)

| Symbol              | Parameter                         | Test Conditions   | Min. | Typ.  | Max. | Unit |
|---------------------|-----------------------------------|---|------|-------|------|------|
| V <sub>GS(th)</sub> | Gate Threshold Voltage            | V <sub>DS</sub> = V <sub>GS</sub> I <sub>D</sub> = 250 μA                               | 2    | 2.9   | 4    | V    |
| R <sub>DS(on)</sub> | Static Drain-source On Resistance | V <sub>GS</sub> = 10V I <sub>D</sub> = 15 A   |      | 0.045 | 0.05 | Ω    |
| I <sub>D(on)</sub>  | On State Drain Current            | V <sub>DS</sub> > I <sub>D(on)</sub> x R <sub>DS(on)max</sub><br>V <sub>GS</sub> = 10 V | 30   |       |      | A    |

DYNAMIC

| Symbol              | Parameter                    | Test Conditions   | Min. | Typ. | Max. | Unit |
|---------------------|------------------------------|---|------|------|------|------|
| g <sub>fs</sub> (*) | Forward Transconductance     | V <sub>DS</sub> > I <sub>D(on)</sub> x R <sub>DS(on)max</sub> I <sub>D</sub> = 15 A | 8    | 12   |      | S    |
| C <sub>iss</sub>    | Input Capacitance            | V <sub>DS</sub> = 25 V f = 1 MHz V <sub>GS</sub> = 0                                |      | 950  | 1250 | pF   |
| C <sub>oss</sub>    | Output Capacitance           |   |      | 420  | 600  | pF   |
| C <sub>rss</sub>    | Reverse Transfer Capacitance |   |      | 110  | 200  | pF   |

**ELECTRICAL CHARACTERISTICS** (continued)

**SWITCHING ON**

| Symbol                        | Parameter  | Test Conditions   | Min. | Typ.           | Max.      | Unit           |
|-------------------------------|--|---|------|----------------|-----------|----------------|
| $t_{d(on)}$<br>$t_r$          | Turn-on Time<br>Rise Time                                    | $V_{DD} = 30\text{ V}$ $I_D = 30\text{ A}$<br>$R_G = 50\ \Omega$ $V_{GS} = 10\text{ V}$<br>(see test circuit, figure 3) |      | 50<br>190      | 70<br>270 | ns<br>ns       |
| $(di/dt)_{on}$                | Turn-on Current Slope  | $V_{DD} = 40\text{ V}$ $I_D = 30\text{ A}$<br>$R_G = 50\ \Omega$ $V_{GS} = 10\text{ V}$<br>(see test circuit, figure 5) |      | 190            |           | A/ $\mu$ s     |
| $Q_g$<br>$Q_{gs}$<br>$Q_{gd}$ | Total Gate Charge<br>Gate-Source Charge<br>Gate-Drain Charge | $V_{DD} = 40\text{ V}$ $I_D = 30\text{ A}$ $V_{GS} = 10\text{ V}$   |      | 30<br>11<br>14 | 45        | nC<br>nC<br>nC |

**SWITCHING OFF**

| Symbol                          | Parameter   | Test Conditions   | Min. | Typ.             | Max.              | Unit           |
|---------------------------------|---|---|------|------------------|-------------------|----------------|
| $t_{r(Voff)}$<br>$t_f$<br>$t_c$ | Off-voltage Rise Time<br>Fall Time<br>Cross-over Time | $V_{DD} = 40\text{ V}$ $I_D = 30\text{ A}$<br>$R_G = 50\ \Omega$ $V_{GS} = 10\text{ V}$<br>(see test circuit, figure 5) |      | 120<br>75<br>180 | 170<br>100<br>250 | ns<br>ns<br>ns |

**SOURCE DRAIN DIODE**

| Symbol                            | Parameter  | Test Conditions   | Min. | Typ.            | Max.      | Unit               |
|-----------------------------------|--|---|------|-----------------|-----------|--------------------|
| $I_{SD}$<br>$I_{SDM}(\bullet)$    | Source-drain Current<br>Source-drain Current (pulsed)                        |   |      |                 | 30<br>120 | A<br>A             |
| $V_{SD} (*)$                      | Forward On Voltage   | $I_{SD} = 30\text{ A}$ $V_{GS} = 0$   |      |                 | 1.6       | V                  |
| $t_{rr}$<br>$Q_{rr}$<br>$I_{RRM}$ | Reverse Recovery Time<br>Reverse Recovery Charge<br>Reverse Recovery Current | $I_{SD} = 30\text{ A}$ $di/dt = 100\text{ A}/\mu\text{s}$<br>$V_{DD} = 30\text{ V}$ $T_j = 150\text{ }^\circ\text{C}$<br>(see test circuit, figure 5) |      | 85<br>0.25<br>6 |           | ns<br>$\mu$ C<br>A |

(\*) Pulsed: Pulse duration = 300  $\mu$ s, duty cycle 1.5 %

( $\bullet$ ) Pulse width limited by safe operating area

Safe Operating Areas For TO-220

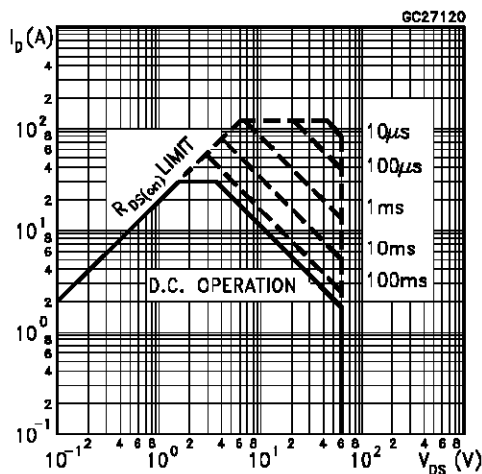

Safe Operating Areas For ISOWATT220

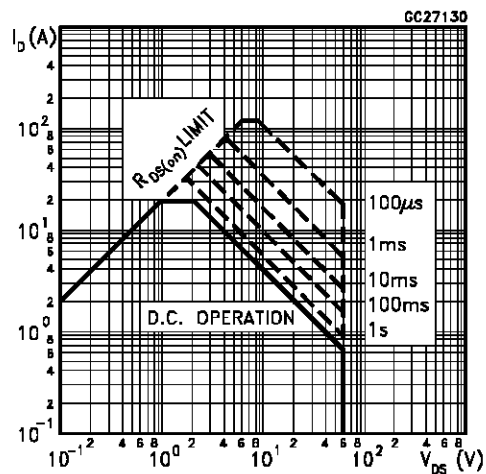

Thermal Impedance For TO-220

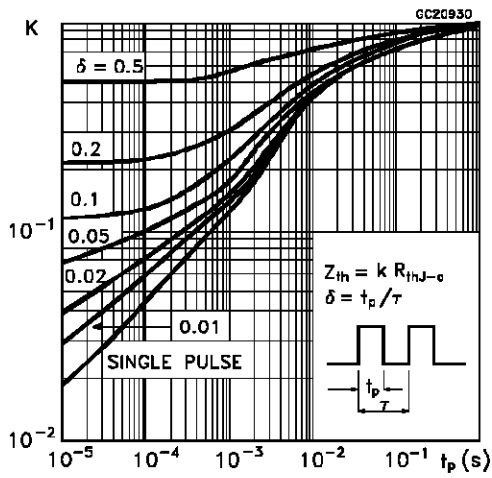

Thermal Impedance For ISOWATT220

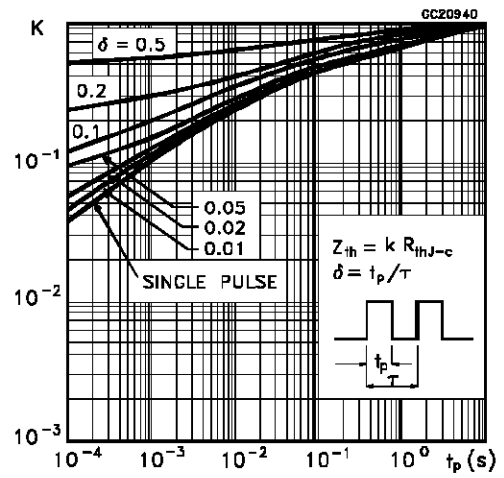

Derating Curve For TO-220

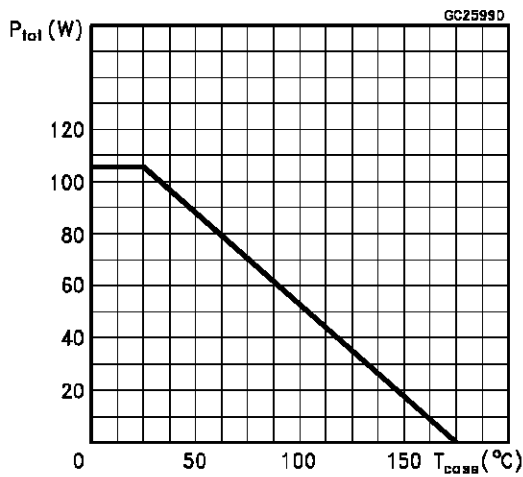

Derating Curve For ISOWATT220

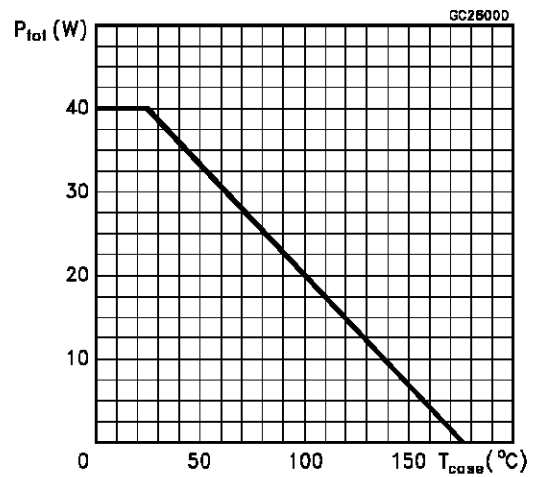

Output Characteristics

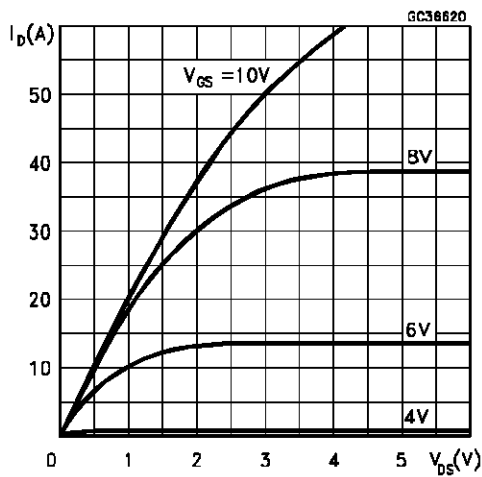

Transfer Characteristics

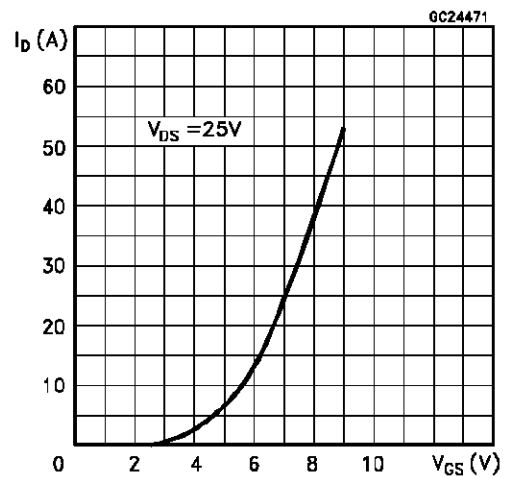

Transconductance

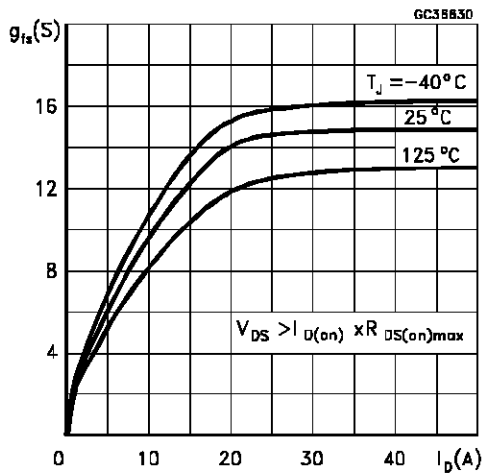

Static Drain-source On Resistance

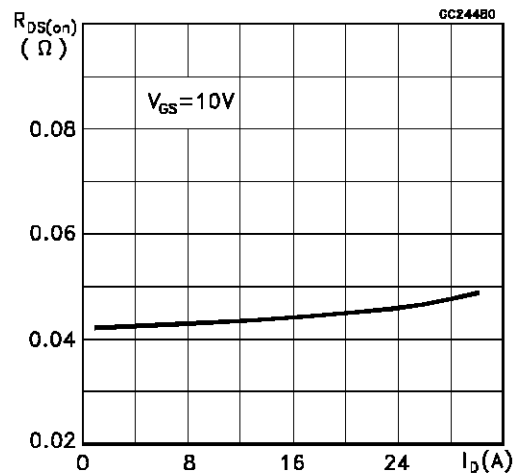

Gate Charge vs Gate-source Voltage

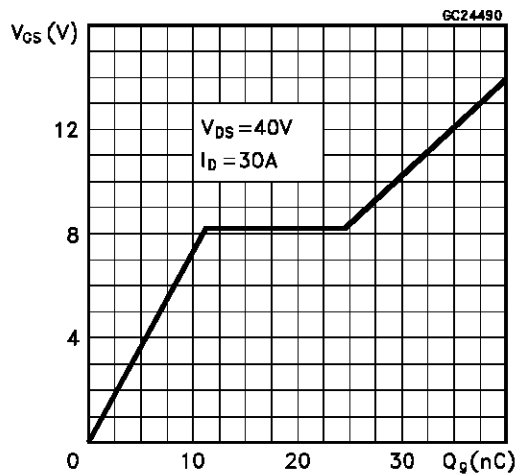

Capacitance Variations

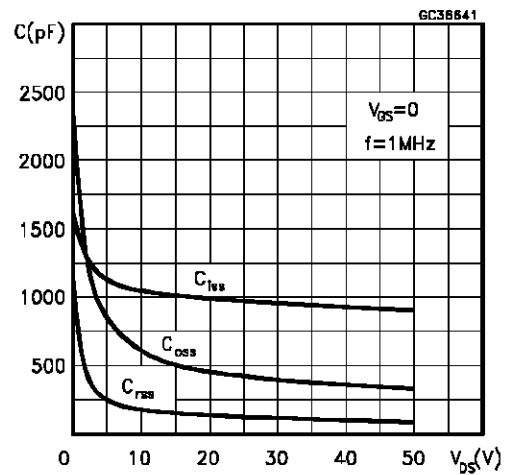

Normalized Gate Threshold Voltage vs Temperature

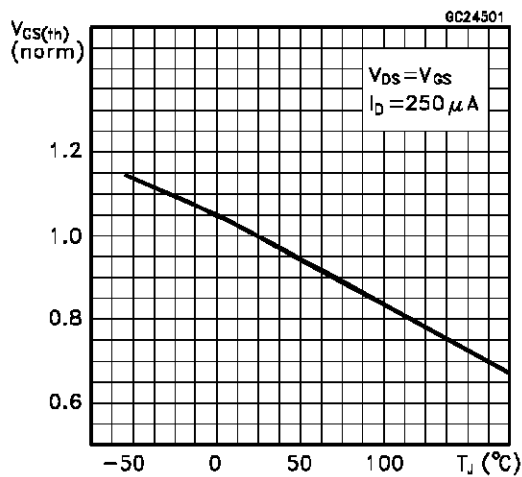

Normalized On Resistance vs Temperature

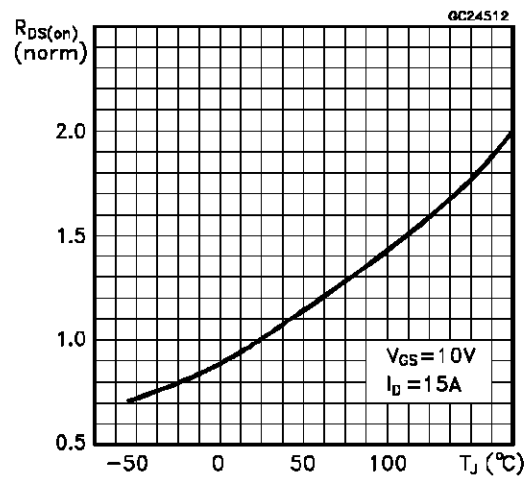

Turn-on Current Slope

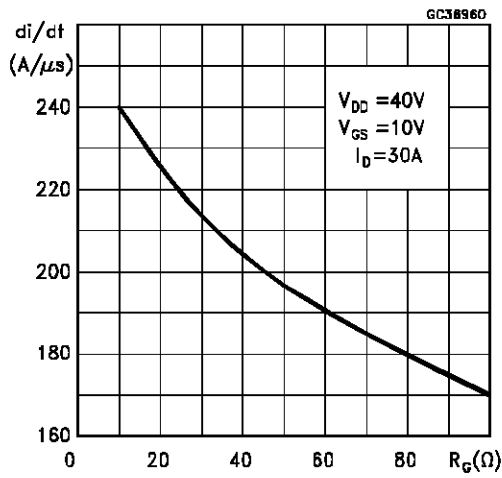

Turn-off Drain-source Voltage Slope

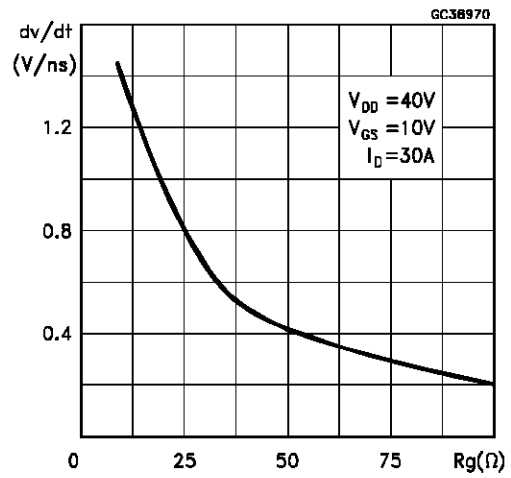

Cross-over Time

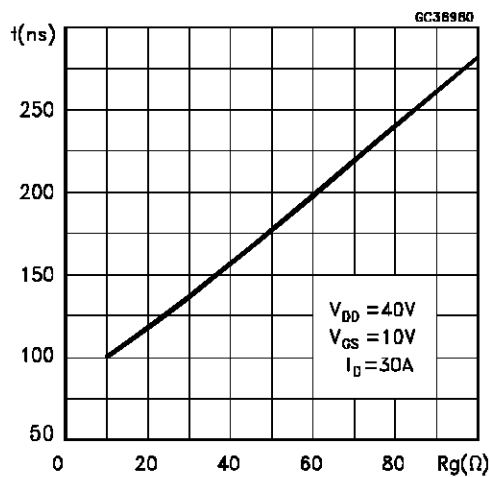

Switching Safe Operating Area

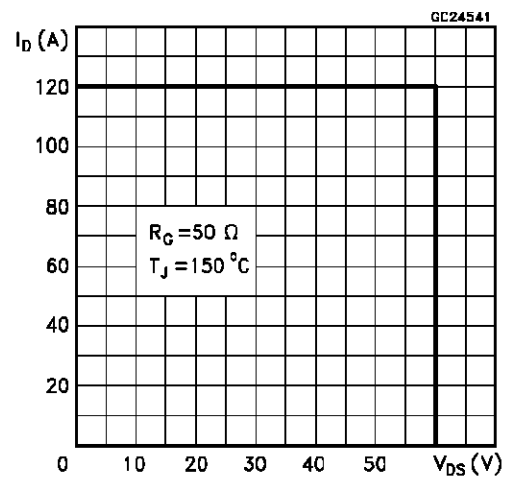

Accidental Overload Area

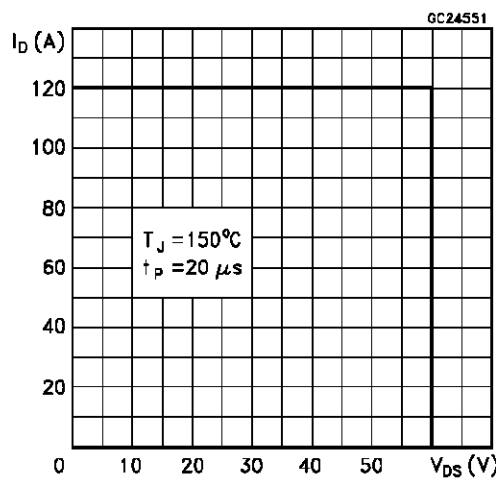

Source-drain Diode Forward Characteristics

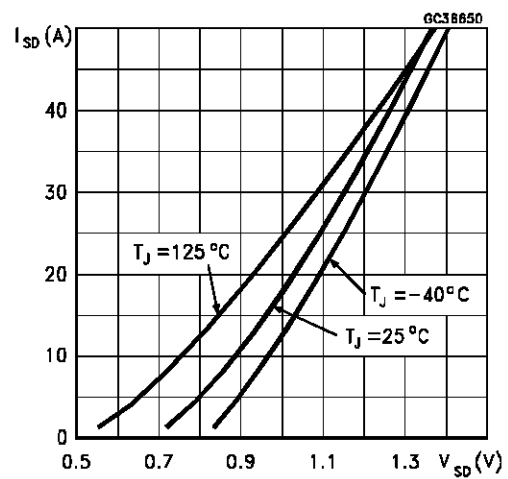

**Fig. 1: Unclamped Inductive Load Test Circuits**



**Fig. 2: Unclamped Inductive Waveforms**



**Fig. 3: Switching Times Test Circuits For Resistive Load**



**Fig. 4: Gate Charge Test Circuit**

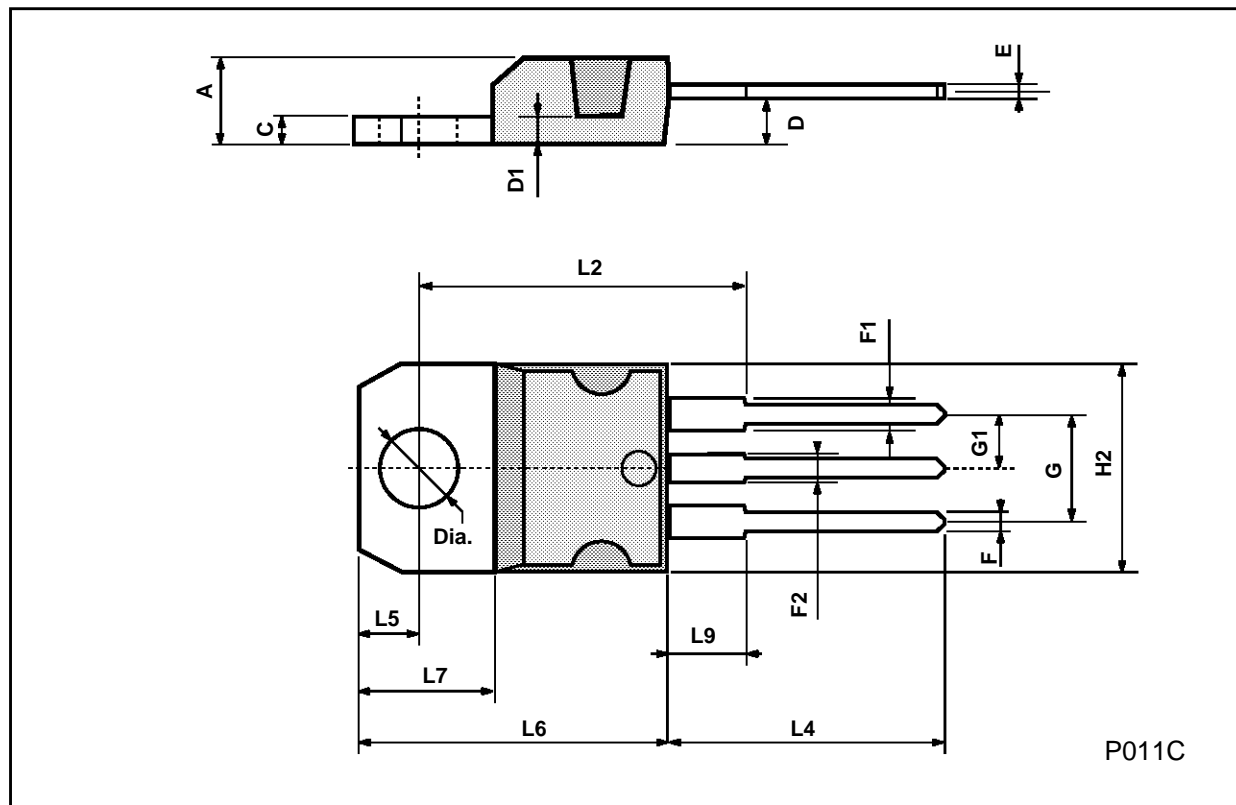

**Fig. 5: Test Circuit For Inductive Load Switching And Diode Reverse Recovery Time**



## TO-220 MECHANICAL DATA

| DIM. | mm    |      |       | inch  |       |       |
|------|-------|------|-------|-------|-------|-------|
|      | MIN.  | TYP. | MAX.  | MIN.  | TYP.  | MAX.  |
| A    | 4.40  |      | 4.60  | 0.173 |       | 0.181 |
| C    | 1.23  |      | 1.32  | 0.048 |       | 0.051 |
| D    | 2.40  |      | 2.72  | 0.094 |       | 0.107 |
| D1   |       | 1.27 |       |       | 0.050 |       |
| E    | 0.49  |      | 0.70  | 0.019 |       | 0.027 |
| F    | 0.61  |      | 0.88  | 0.024 |       | 0.034 |
| F1   | 1.14  |      | 1.70  | 0.044 |       | 0.067 |
| F2   | 1.14  |      | 1.70  | 0.044 |       | 0.067 |
| G    | 4.95  |      | 5.15  | 0.194 |       | 0.203 |
| G1   | 2.4   |      | 2.7   | 0.094 |       | 0.106 |
| H2   | 10.0  |      | 10.40 | 0.393 |       | 0.409 |
| L2   |       | 16.4 |       |       | 0.645 |       |
| L4   | 13.0  |      | 14.0  | 0.511 |       | 0.551 |
| L5   | 2.65  |      | 2.95  | 0.104 |       | 0.116 |
| L6   | 15.25 |      | 15.75 | 0.600 |       | 0.620 |
| L7   | 6.2   |      | 6.6   | 0.244 |       | 0.260 |
| L9   | 3.5   |      | 3.93  | 0.137 |       | 0.154 |
| DIA. | 3.75  |      | 3.85  | 0.147 |       | 0.151 |





## ISOWATT220 MECHANICAL DATA

| DIM. | mm   |      |      | inch  |       |       |
|------|------|------|------|-------|-------|-------|
|      | MIN. | TYP. | MAX. | MIN.  | TYP.  | MAX.  |
| A    | 4.4  |      | 4.6  | 0.173 |       | 0.181 |
| B    | 2.5  |      | 2.7  | 0.098 |       | 0.106 |
| D    | 2.5  |      | 2.75 | 0.098 |       | 0.108 |
| E    | 0.4  |      | 0.7  | 0.015 |       | 0.027 |
| F    | 0.75 |      | 1    | 0.030 |       | 0.039 |
| F1   | 1.15 |      | 1.7  | 0.045 |       | 0.067 |
| F2   | 1.15 |      | 1.7  | 0.045 |       | 0.067 |
| G    | 4.95 |      | 5.2  | 0.195 |       | 0.204 |
| G1   | 2.4  |      | 2.7  | 0.094 |       | 0.106 |
| H    | 10   |      | 10.4 | 0.393 |       | 0.409 |
| L2   |      | 16   |      |       | 0.630 |       |
| L3   | 28.6 |      | 30.6 | 1.126 |       | 1.204 |
| L4   | 9.8  |      | 10.6 | 0.385 |       | 0.417 |
| L6   | 15.9 |      | 16.4 | 0.626 |       | 0.645 |
| L7   | 9    |      | 9.3  | 0.354 |       | 0.366 |
| Ø    | 3    |      | 3.2  | 0.118 |       | 0.126 |



Information furnished is believed to be accurate and reliable. However, SGS-THOMSON Microelectronics assumes no responsibility for the consequences of use of such information nor for any infringement of patents or other rights of third parties which may result from its use. No license is granted by implication or otherwise under any patent or patent rights of SGS-THOMSON Microelectronics. Specifications mentioned in this publication are subject to change without notice. This publication supersedes and replaces all information previously supplied. SGS-THOMSON Microelectronics products are not authorized for use as critical components in life support devices or systems without express written approval of SGS-THOMSON Microelectronics.

© 1996 SGS-THOMSON Microelectronics - Printed in Italy - All Rights Reserved

SGS-THOMSON Microelectronics GROUP OF COMPANIES

Australia - Brazil - Canada - China - France - Germany - Hong Kong - Italy - Japan - Korea - Malaysia - Malta - Morocco - The Netherlands - Singapore - Spain - Sweden - Switzerland - Taiwan - Thailand - United Kingdom - U.S.A

This datasheet has been download from:

[www.datasheetcatalog.com](http://www.datasheetcatalog.com)

Datasheets for electronics components.