

# MBRS320T3G, SBRS8320T3G, MBRS330T3G, NRVBS330T3G, MBRS340T3G, SBRS8340T3G

## Surface Mount Schottky Power Rectifier

These devices employ the Schottky Barrier principle in a large area metal-to-silicon power diode. State-of-the-art geometry features epitaxial construction with oxide passivation and metal overlay contact. Ideally suited for low voltage, high frequency rectification, or as free wheeling and polarity protection diodes, in surface mount applications where compact size and weight are critical to the system.

### Features

- Small Compact Surface Mountable Package with J-Bend Leads
- Rectangular Package for Automated Handling
- Highly Stable Oxide Passivated Junction
- Very Low Forward Voltage Drop  
(0.5 V Max @ 3.0 A, T<sub>J</sub> = 25°C)
- Excellent Ability to Withstand Reverse Avalanche Energy Transients
- Guard-Ring for Stress Protection
- Device Passes ISO 7637 Pulse #1
- SBRS8 and NRVB Prefix for Automotive and Other Applications Requiring Unique Site and Control Change Requirements; AEC-Q101 Qualified and PPAP Capable\*
- These Devices are Pb-Free, Halogen Free/BFR Free and are RoHS Compliant

### Mechanical Characteristics

- Case: Epoxy, Molded, Epoxy Meets UL 94 V-0
- Weight: 217 mg (Approximately)
- Finish: All External Surfaces Corrosion Resistant and Terminal Leads are Readily Solderable
- Lead and Mounting Surface Temperature for Soldering Purposes: 260°C Max. for 10 Seconds
- Polarity: Polarity Band on Plastic Body Indicates Cathode Lead
- Device Meets MSL 1 Requirements
- ESD Ratings:
  - ◆ Machine Model = C (> 400 V)
  - ◆ Human Body Model = 3B (> 8000 V)



ON Semiconductor®

[www.onsemi.com](http://www.onsemi.com)

**SCHOTTKY BARRIER  
RECTIFIERS  
3.0 AMPERES  
20, 30, 40 VOLTS**



SMC 2-LEAD  
CASE 403AC

### MARKING DIAGRAM

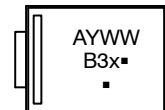

- B3x = Device Code
- x = 2, 3 or 4
- A = Assembly Location\*\*
- Y = Year
- WW = Work Week
- = Pb-Free Package

(Note: Microdot may be in either location)

\*\*The Assembly Location code (A) is front side optional. In cases where the Assembly Location is stamped in the package, the front side assembly code may be blank.

### ORDERING INFORMATION

Device	Package	Shipping†
MBRS320T3G	SMC (Pb-Free)	2,500 / Tape & Reel
MBRS330T3G	SMC (Pb-Free)	2,500 / Tape & Reel
MBRS340T3G	SMC (Pb-Free)	2,500 / Tape & Reel
NRVBS330T3G	SMC (Pb-Free)	2,500 / Tape & Reel
SBRS8320T3G*	SMC (Pb-Free)	2,500 / Tape & Reel
SBRS8340T3G*	SMC (Pb-Free)	2,500 / Tape & Reel

†For information on tape and reel specifications, including part orientation and tape sizes, please refer to our Tape and Reel Packaging Specification Brochure, BRD8011/D.

# MBRS320T3G, SBRS8320T3G, MBRS330T3G, NRVBS330T3G, MBRS340T3G, SBRS8340T3G

## MAXIMUM RATINGS

Rating	Symbol	MBRS320T3G, SBRS8320T3G	MBRS330T3G, NRVBS330T3G	MBRS340T3G, SBRS8340T3G	Unit
Peak Repetitive Reverse Voltage Working Peak Reverse Voltage DC Blocking Voltage	$V_{RRM}$ $V_{RWM}$ $V_R$	20	30	40	V
Average Rectified Forward Current	$I_{F(AV)}$	3.0 @ $T_L = 110^\circ\text{C}$ 4.0 @ $T_L = 105^\circ\text{C}$			A
Nonrepetitive Peak Surge Current (Surge applied at rated load conditions halfwave, single phase, 60 Hz)	$I_{FSM}$	80			A
Operating Junction Temperature	$T_J$	- 65 to +150			$^\circ\text{C}$
ISO 7637 Pulse #1 (100 V, 10 $\Omega$ )		5000			Pulses
ESD Ratings: Machine Model = C Human Body Model = 3B		> 400 > 8000			V

Stresses exceeding those listed in the Maximum Ratings table may damage the device. If any of these limits are exceeded, device functionality should not be assumed, damage may occur and reliability may be affected.

## THERMAL CHARACTERISTICS

Thermal Resistance, Junction-to-Lead	$R_{\theta JL}$	11	$^\circ\text{C/W}$
--------------------------------------	-----------------	----	--------------------

## ELECTRICAL CHARACTERISTICS

Maximum Instantaneous Forward Voltage (Note 1) ( $i_F = 3.0\text{ A}$ , $T_J = 25^\circ\text{C}$ )	$V_F$	0.50	V
Maximum Instantaneous Reverse Current (Note 1) (Rated dc Voltage, $T_J = 25^\circ\text{C}$ ) (Rated dc Voltage, $T_J = 100^\circ\text{C}$ )	$i_R$	2.0 20	mA

Product parametric performance is indicated in the Electrical Characteristics for the listed test conditions, unless otherwise noted. Product performance may not be indicated by the Electrical Characteristics if operated under different conditions.

1. Pulse Test: Pulse Width = 300  $\mu\text{s}$ , Duty Cycle  $\leq 2.0\%$ .

## TYPICAL ELECTRICAL CHARACTERISTICS

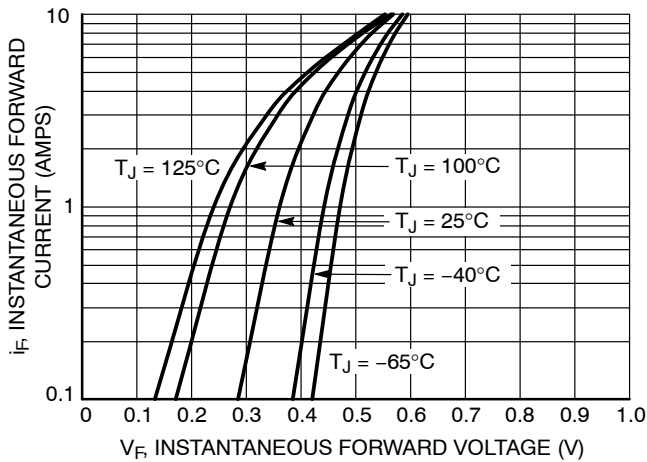

Figure 1. Typical Forward Voltage

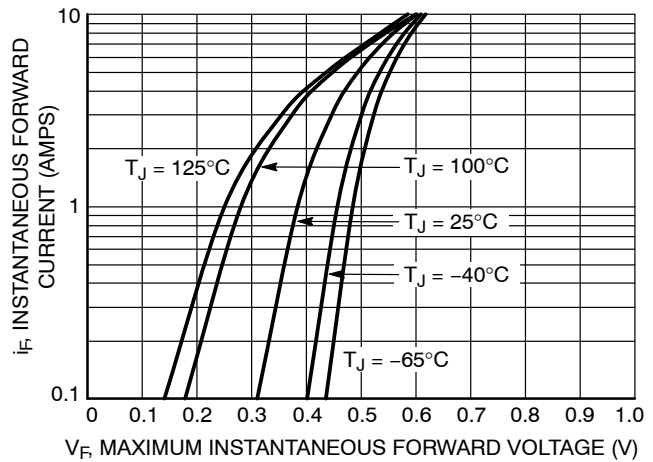
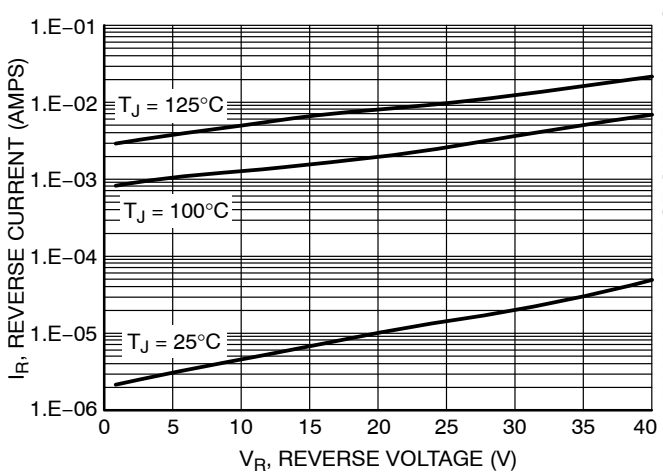

Figure 2. Maximum Forward Voltage

**MBRS320T3G, SBRS8320T3G, MBRS330T3G, NRVBS330T3G, MBRS340T3G, SBRS8340T3G**

**TYPICAL ELECTRICAL CHARACTERISTICS (continued)**



**Figure 3. Typical Reverse Current**

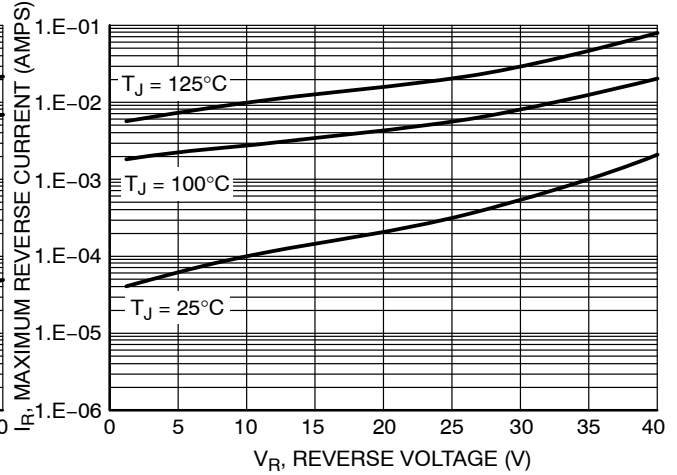

**Figure 4. Maximum Reverse Current**

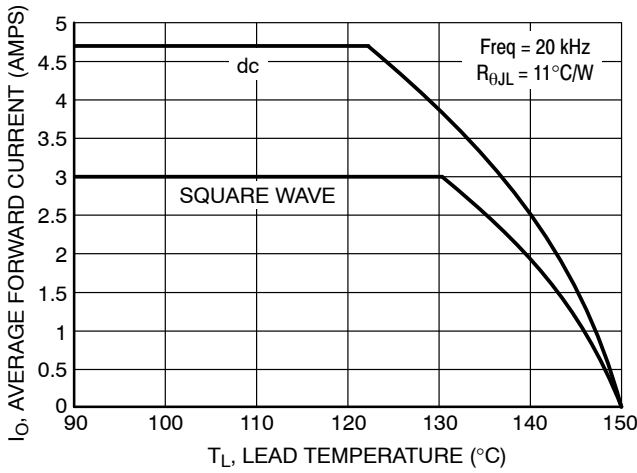

**Figure 5. Current Derating**

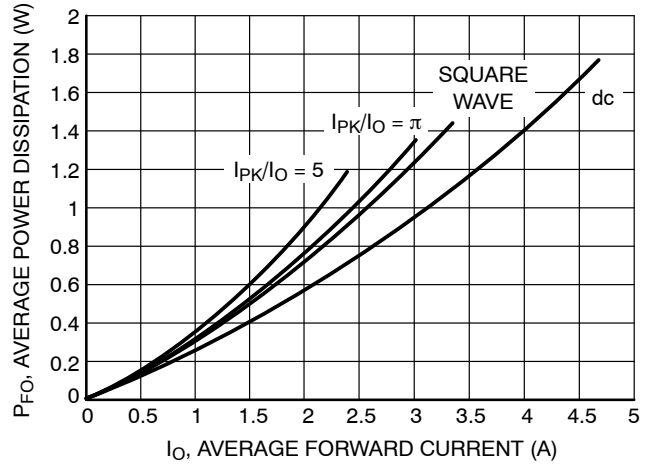

**Figure 6. Forward Power Dissipation**

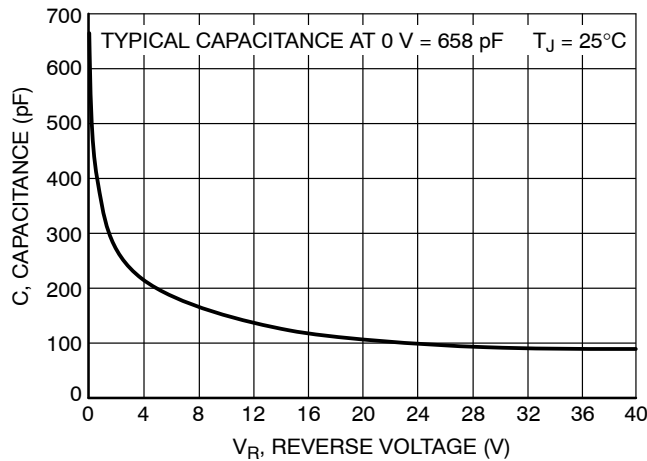
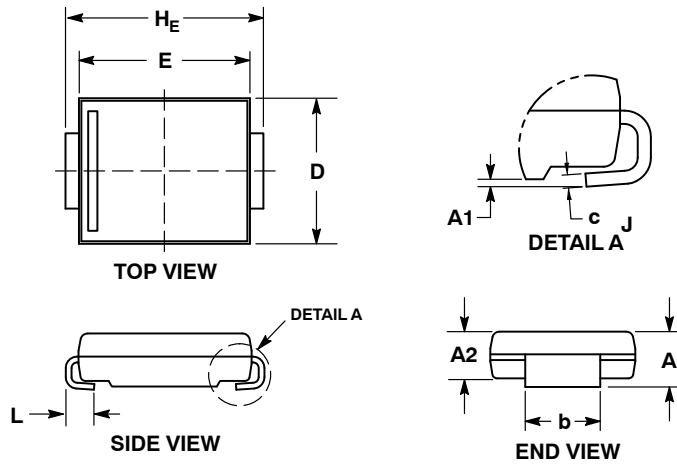

**Figure 7. Typical Capacitance**

# MBRS320T3G, SBRS8320T3G, MBRS330T3G, NRVBS330T3G, MBRS340T3G, SBRS8340T3G

## PACKAGE DIMENSIONS

### SMC 2-LEAD CASE 403AC ISSUE B



#### NOTES:

1. DIMENSIONING AND TOLERANCING PER ANME Y14.5M, 1994.
2. CONTROLLING DIMENSION: INCHES.
3. DIMENSIONS D AND E DO NOT INCLUDE MOLD FLASH. MOLD FLASH SHALL NOT EXCEED 0.254mm PER SIDE.
4. DIMENSIONS D AND E TO BE DETERMINED AT DATUM H.
5. DIMENSION b SHALL BE MEASURED WITHIN THE AREA DETERMINED BY DIMENSION L.

DIM	MILLIMETERS		INCHES	
	MIN	MAX	MIN	MAX
A	1.95	2.61	0.077	0.103
A1	0.05	0.20	0.002	0.008
A2	1.90	2.41	0.075	0.095
b	2.90	3.20	0.114	0.126
c	0.15	0.41	0.006	0.016
D	5.55	6.25	0.219	0.246
E	6.60	7.15	0.260	0.281
HE	7.75	8.15	0.305	0.321
L	0.75	1.60	0.030	0.063

### RECOMMENDED SOLDERING FOOTPRINT\*

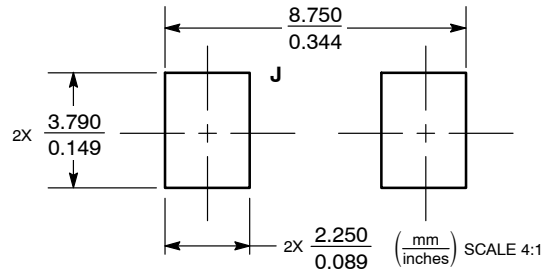

\*For additional information on our Pb-Free strategy and soldering details, please download the ON Semiconductor Soldering and Mounting Techniques Reference Manual, SOLDERRM/D.

ON Semiconductor and are trademarks of Semiconductor Components Industries, LLC dba ON Semiconductor or its subsidiaries in the United States and/or other countries. ON Semiconductor owns the rights to a number of patents, trademarks, copyrights, trade secrets, and other intellectual property. A listing of ON Semiconductor's product/patent coverage may be accessed at [www.onsemi.com/site/pdf/Patent-Marking.pdf](http://www.onsemi.com/site/pdf/Patent-Marking.pdf). ON Semiconductor reserves the right to make changes without further notice to any products herein. ON Semiconductor makes no warranty, representation or guarantee regarding the suitability of its products for any particular purpose, nor does ON Semiconductor assume any liability arising out of the application or use of any product or circuit, and specifically disclaims any and all liability, including without limitation special, consequential or incidental damages. Buyer is responsible for its products and applications using ON Semiconductor products, including compliance with all laws, regulations and safety requirements or standards, regardless of any support or applications information provided by ON Semiconductor. "Typical" parameters which may be provided in ON Semiconductor data sheets and/or specifications can and do vary in different applications and actual performance may vary over time. All operating parameters, including "Typicals" must be validated for each customer application by customer's technical experts. ON Semiconductor does not convey any license under its patent rights nor the rights of others. ON Semiconductor products are not designed, intended, or authorized for use as a critical component in life support systems or any FDA Class 3 medical devices or medical devices with a same or similar classification in a foreign jurisdiction or any devices intended for implantation in the human body. Should Buyer purchase or use ON Semiconductor products for any such unintended or unauthorized application, Buyer shall indemnify and hold ON Semiconductor and its officers, employees, subsidiaries, affiliates, and distributors harmless against all claims, costs, damages, and expenses, and reasonable attorney fees arising out of, directly or indirectly, any claim of personal injury or death associated with such unintended or unauthorized use, even if such claim alleges that ON Semiconductor was negligent regarding the design or manufacture of the part. ON Semiconductor is an Equal Opportunity/Affirmative Action Employer. This literature is subject to all applicable copyright laws and is not for resale in any manner.

### PUBLICATION ORDERING INFORMATION

**LITERATURE FULFILLMENT:**  
Literature Distribution Center for ON Semiconductor  
19521 E. 32nd Pkwy, Aurora, Colorado 80011 USA  
**Phone:** 303-675-2175 or 800-344-3860 Toll Free USA/Canada  
**Fax:** 303-675-2176 or 800-344-3867 Toll Free USA/Canada  
**Email:** [orderlit@onsemi.com](mailto:orderlit@onsemi.com)

**N. American Technical Support:** 800-282-9855 Toll Free  
USA/Canada  
**Europe, Middle East and Africa Technical Support:**  
Phone: 421 33 790 2910  
**Japan Customer Focus Center**  
Phone: 81-3-5817-1050

**ON Semiconductor Website:** [www.onsemi.com](http://www.onsemi.com)  
**Order Literature:** <http://www.onsemi.com/orderlit>

For additional information, please contact your local Sales Representative